

CUSTOMER : _____

DATE: 2010-10-10

SPECIFICATION

PRODUCT: USB CHARGER
MODEL NO. QIW-05W-0510L
SPEC NO. C001-003
VERSION : A1

RoHS COMPLIANT



Receiver's stamp or signature

**PLEASE APPROVE & RETURN BEFORE 2010-10-25
OR WE WOULD REGARD IT BEEN CONFIRMED.**

RESPONSIBLE	APPROVED	ISSUED
Thomson	Aiwei	Anni

ISSUES STAMP

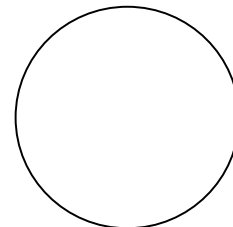

Revised History

NO.	Revised Date	Description	Approved	Issued

Qiw Power Supply Co., Limited

CHINA:

Http://www.qiw.com
E-mail: qiw@qiw.com
TEL : +86-755-89809888 33034333
FAX : +86-755-85522111

HONG KONG:

Http://www.qiw.com.hk
E-mail: qiw@qiw.com.hk
TEL : +852-65548111
FAX : +852-83437988

	DESCRIPTION	USB CHARGER	SHEET	1 OF 4
	MODEL NO.	QIW-05W-0510L	VERSION:	A1
			SPEC NO.	C001-003

1.INPUT REQUIREMENT

2.OUTPUT SPECIFICATION

3.MECHANICAL

4.RELIABILITY

5.ENVIRONMENT

6.OUTLOOKING

7.SAFETY

8.QC CHECK

9.DIMENSION

10.LABEL

11.PACKING

	DESCRIPTION	USB CHARGER	SHEET NO.	2 OF 4
	MODEL NO.	QIW-05W-0510L	VERSION:	A1
			SPEC NO.	C001-003

1.INPUT REQUIREMENT

ITEM	SPECIFICATION	MIN	TYP.	MAX
NORMAL AC INPUT VOLTAGE	SINGLE PHASE	100Vac	110Vac/220Vac	240Vac
AC INPUT VOLTAGE RANGE	SINGLE PHASE	90Vac	110Vac/220Vac	264Vac
AC INPUT FREQUENCY	SINGLE PHASE	47Hz	50/60Hz	63Hz
AC INPUT CURRENT	TYPICAL INPUT VOLTAGE& OUTPUT AT FULL LOAD.			200mA
AC INRUSH CURRENT	TYPICAL INPUT VOLTAGE& OUTPUT AT FULL LOAD , 25°C.			30A
EFFICIENCY	TYPICAL INPUT VOLTAGE& OUTPUT AT FULL LOAD	70%		

2.OUTPUT SPECIFICATION

ITEM	SPECIFICATION	MIN	TYP.	MAX
NORMAL DC OUTPUT VOLTAGE			5.0Vdc	
DC OUTPUT VOLTAGE RANGE	TYPICAL OUTPUT VOLTAGE $\pm 5\%$	4.75V		5.25V
LOAD CURRENT RANGE		0.1A		1.0A
PEAK LOAD CURRENT	TIME<60S			1.1A
RIPPLE	TYPICAL INPUT VOLTAGE , TYPICAL LOAD CURRENT , 25°C			50mV
HOLD-UP TIME	AT TYPICAL INPUT VOLTAGE AND FULL LOAD	10mS		
TURN-ON DELAY	TYPICAL INPUT VOLTAGE AND TUP LOAD CURRENT			1S
OVER CURRENT PROTECTION	AUTO RECOVERY			
SHORT CIRCUIT PROTECTRON	THE ADAPTER SHALL NOT DAMAGE BY SHORT THE DC OUTPUT TO GROUND			
NO LOAD POWER DISSIPATION				0.3W
OVER VOLTAGE PROTECTION			6V	7.5V

*TEST MEASURES

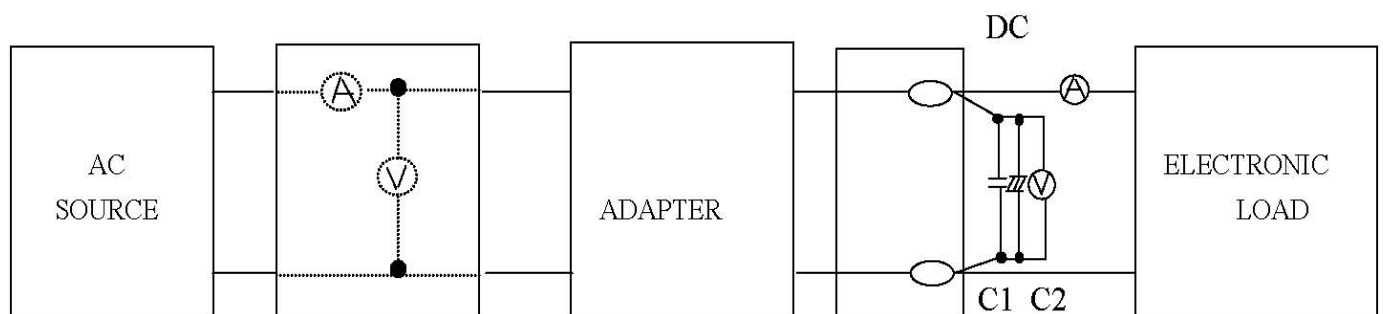

C1: 0.1uF CERAMICS CAPACITOR

C2: 10uF 50V ALUMINUM CAPACITOR

	DESCRIPTION	USB CHARGER	SHEET NO.	3 OF 4
			VERSION:	A1
	MODEL NO.	QIW-05W-0510L	SPEC NO.	C001-003

3.MECHANICAL

ITEM	SPECIFICATION OR TEST CONDITION	ACCEPTANCE CRITERIA
BENDING TEST	NORMAL TEMPERATURE THE CORD SHALL WITHSTAND WEIGHT OF 200g, SWINGING FROM LEFT TO RIGHT AT AN ANGLE OF 60 DEG. 1000CYCLE TIMES MIN. S/R SHALL WITHSTAND WEIGHT OF 1N. SWINGING FROM LEFT TO RIGHT AT AN ANGLE OF 60DEG. 1000CYCLE TIMES MIN. BENDING SPEED 40CYCLE/MINUTE	NO SHORT CIRCUIT NO BREAKAGE OF THE CORD
VIBRATION	FREQUENCY RANGE:10~55Hz AMPLITUDE:1.5mm ACCELERATION: 1G SWEEP 1 MINUTE FOR X,Y,Z,AXIS EACH	THERE SHALL BENO ABNORMALITY ON THE APPEARANCE STRUCTURE AND OPERATING

4.RELIABILITY

ITEM	TEST CONDITION	ACCEPTANCE CRITERIA
TEMPERATURE UP WITH TYPICAL LOAD	TEST AT SURFACE OF THE CASE WITH TYPICAL AC INPUT AND TYPICAL LOAD IN OUTPUT	TEMPERATURE UP UNDER 35 DEGREES
	50/60Hz	
HI-POT TEST	INPUT TO OUTPUT GRADUALLY RAISED FROM 0 TO THE 3000Vac AND HELD AT THAT VALUE FOR 3S,5mA	NO DAMAGE
MTBF	TYPICAL INPUT&FULL LOAD , 25℃	50000 HOURS
LIFE	TYPICAL INPUT&FULL LOAD, 40℃ TYPICAL INPUT&FULL LOAD, 25℃	1YEARS ABOVE 2YEARS ABOVE
BURN-IN	AT 30℃(±10℃),NORMAL INPUT VOLTAGE	2~4 HOURS

5.ENVIRONMENT

ITEM	SPECIFICATION OR TEST CONDITION	min.	typ.	max.
OPERATING TEMPERATURE		0℃		40℃
STORAGE TEMPERATURE		-20℃		85℃
OPERATING HUMIDITY	NON-CONDENSING	5%RH		90%RH
STORAGE HUMIDITY	NON-CONDENSING	5%RH		90%RH

	DESCRIPTION	USB CHARGER	SHEET NO.	4 OF 4
			VERSION:	A1
	MODEL NO.	QIW-05W-0510L	SPEC NO.	C001-003

6.OUTLOOKING

DIMENSION :60(L)X40(W)X21.5(H)mm
 WEIGHT :ABOUT 120g
 AC INPUT TYPE :2PIN INLET with interchangeable ac plugs
 DC OUTPUT TYPE :USB A/F (母座)

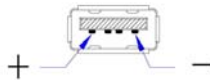

DC OUTPUT CABLE INDICATION :LABEL
 CASE MATERIAL :94V-0 ABS+PC
 PCB MATERIAL :94V-0

7.SAFETY

COMPLY SAFETY STANDARDS	STANDARD	FILE NO.
UL CUL		
PSE		
EMI		
FCC CE		

8.QC CHECK

ALL OF THE QUANTITY SHALL BE CHECKED BEFORE SHIPMENT,CHECK ITEM AS BELOW:
 (1)DC PLUG POLE CHECK
 (2)OCP FUNCTION CHECK
 (3)DC OUTPUT VOLTAGE CHECK
 (4)HIPOT&INSULATION CHECK
 (5)OUTLOOKING CHECK

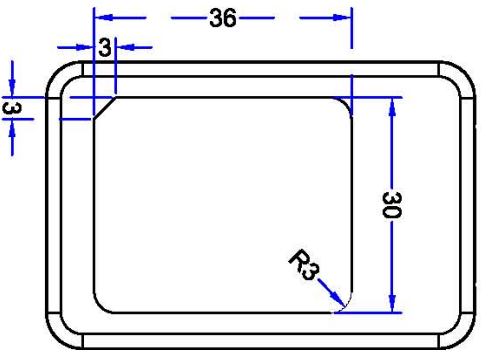
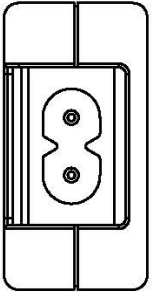

PIN: 4" -"
PIN: 1" +"

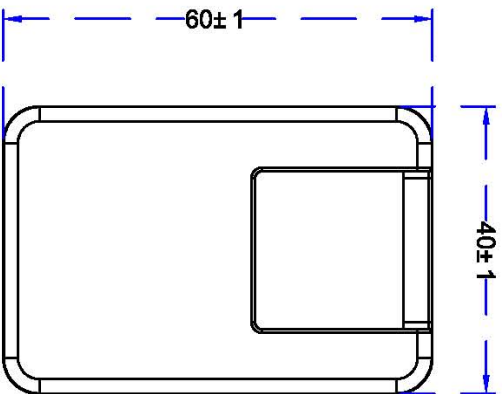
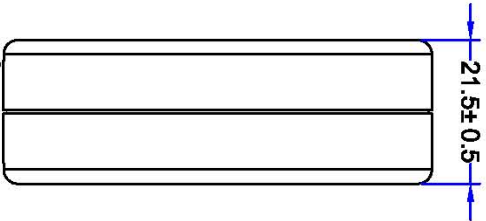
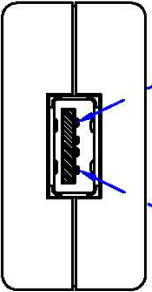

TOLERANCE							FINISH		MATERIAL		SCALE		PART NO.		
1:4	1:5	1:10	1:20	1:50	1:100	1:200	1:500	1:1000	1:2000	1:5000	1:10000	1:20000	1:50000	1:100000	1:200000
±0.05	±0.07	±0.10	±0.15	±0.20	±0.30	±0.40	±0.50	±0.60	±0.70	±0.80	±0.90	±1.00	±1.20	±1.50	±2.00
MATERIAL		UNIT		REV.		NAME		DIMENSION		SCALE		PART NO.		C001-003	
XXXXXX		mm		A1		DIMENSION		1:1		C001-003					
XXXXXX		mm		A1		DIMENSION		1:1		C001-003					
XXXXXX		mm		A1		DIMENSION		1:1		C001-003					

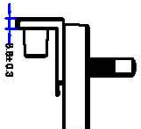
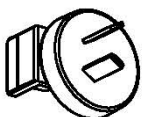
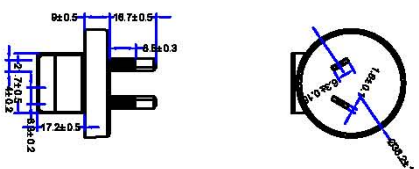
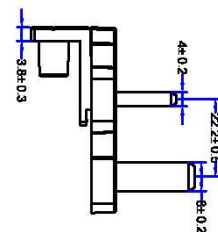
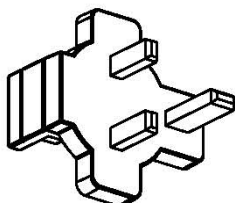
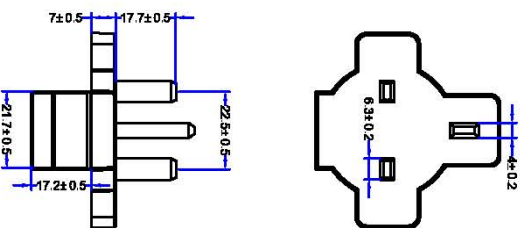
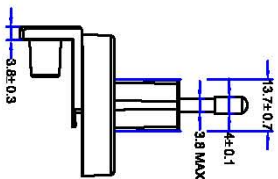
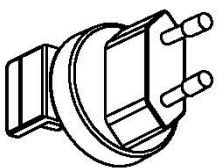
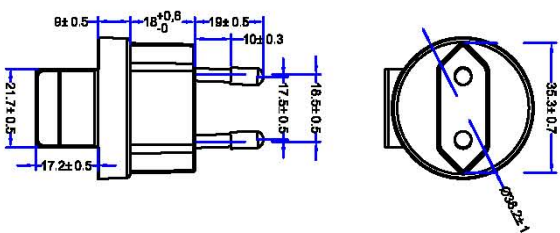
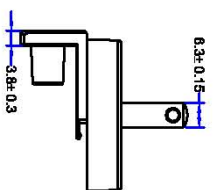
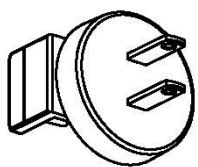
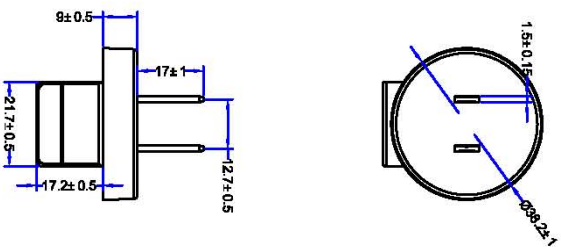

TOLERANCE	
L44	±0.05 ±0.08 ±0.1 ±0.2
44420	±0.05 ±0.1 ±0.2 ±0.3
20-4450	±0.1 ±0.2 ±0.3 ±0.4
50-45200	±0.15 ±0.25 ±0.3 ±0.6
200-4	±0.2 ±0.4 ±0.5 ±0.8

FINISH	XXXXXX
MATERIAL	XXX
UNIT	mm
REV.	A1

NAME	DIMENSION
SCALE	
DWG NO.	XXXX
PART NO.	C001-003

APPR.	CHKD.	DATE

ANNT	SCALE

PART NO.	C001-003

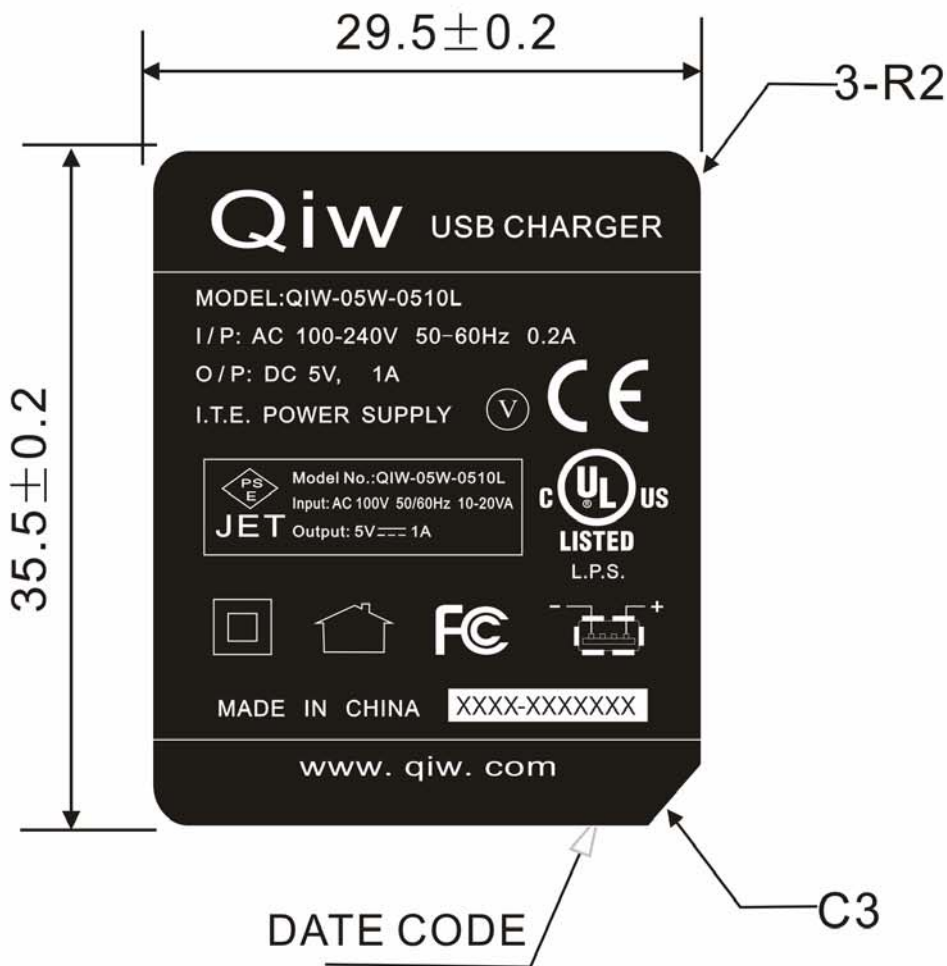

XXXX-XXXXXXX



NOTE:

- 1.SILVER WORD ON BLACK BASE.
- 2.MATERIAL:PVC + MYLAR FILM.

TOLERANCE					FINISH				NAME	LABEL
L ≤ 4	4 < L ≤ 20	20 < L ≤ 50	50 < L ≤ 200	200 < L		MATERIAL	REV.	A1		
0.05	0.08	0.1	0.2	0.3						
0.08	0.1	0.15	0.3	0.4						
0.1	0.15	0.25	0.4	0.6						
0.15	0.25	0.4	0.6	0.8						
0.2	0.4	0.5	0.8							
DEG.	CHKD.	APPD.	SCALE		UNIT	mm			PART NO.	C001-003
Anni	Aiwei	Thomson	REF.							
			DWG NO.		AD00008					

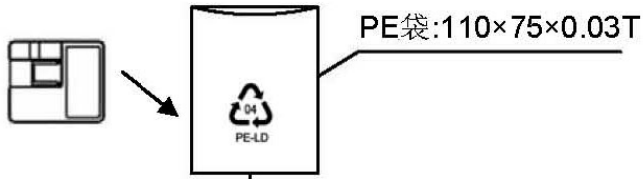

注:PE袋和汽泡袋不要用胶纸固定

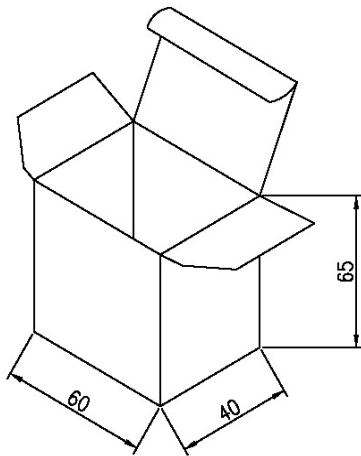
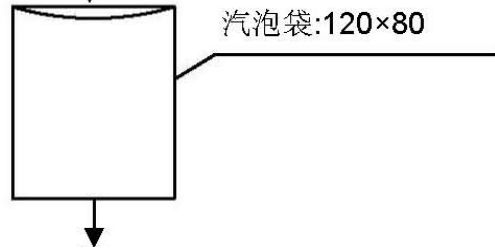

小白盒 500g

外徑寸法 長X寬X高

60×40×65

TOLERANCE:±1

一个小白盒内放一个产品

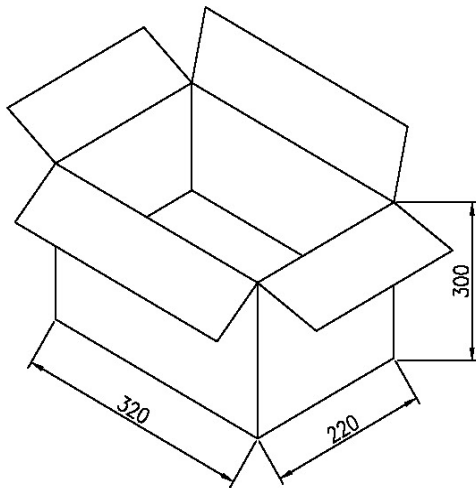

外箱:(K=K)

成品100PCS 放入

外徑寸法 長X寬X高

320X220X300

TOLERANCE:±3

TOLERANCE					FINISH				NAME	PACKING
L≤4	4<L≤20	20<L≤50	50<L≤200	200<L		MATERIAL	REV.	A1		
±0.05	±0.08	±0.1	±0.2	±0.3						
±0.08	±0.1	±0.2	±0.3	±0.4						
±0.1	±0.15	±0.3	±0.4	±0.6						
±0.15	±0.25	±0.4	±0.6	±0.8						
±0.2	±0.4	±0.5	±0.8							
DEG.	CHKD.	APPD.	UNIT		mm			PART NO.	C001-003	
			SCALE <td>REF. <td colspan="3"></td> </td>	REF. <td colspan="3"></td>						
Anni				DWG NO.						